



UNI EN 1303:2015



I cilindri EvoK22 sono testati dall'Istituto Giordano secondo il rapporto di prova n. 340688, in base alla norma UNI EN 1303/2015, ottenendo nelle varie prove i massimi

The EvoK22 cylinders are tested by the Institute Giordano test report no. 340688 according to the UNI EN 1303/2015 obtaining maximum results in the various tests.



1	2	3	4	5	6	7	8
1	6	0	0	0	C	6	D

2 - DURABILITY: 6 (max = 6 = > 100.000 cycles) 7 - KEY RELATED SECURITY: 6 (max = 6 = > 100.000 combinations) 8 - ATTACK RESISTANCE: D (max = D = 5-10 min)

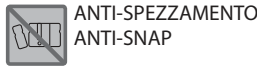
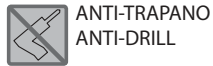

Securemme Vi ringrazia per la fiducia accordata scegliendo questo prodotto e Vi invita a prendere visione delle seguenti istruzioni.

1) COME SCEGLIERE E MISURARE UN CILINDRO

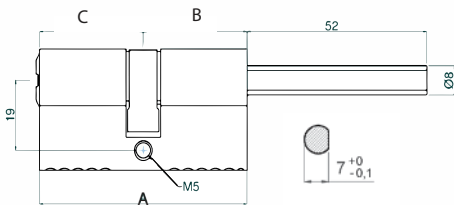
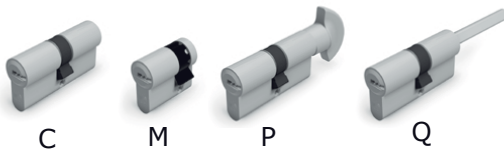

2) DOTAZIONE

1 chiave cantiere, 3/5 chiavi di ottone nichelato, security card in confezione sigillata. Vite di fissaggio. Forma ergonomica della chiave con inserto personalizzabile. Design e sistema brevettato.

3) SISTEMA CHIAVE DA CANTIERE

Si utilizza la prima chiave (C) in fase di cantiere e si consegna al proprietario il set sigillato di chiavi. Al primo utilizzo delle chiavi sigillate la cifratura viene modificata rendendo inutilizzabile la prima chiave (C)



4) SECURITY CARD

La security card ti tutela contro le duplicazioni illecite perchè le chiavi sono duplicabili SOLO presso i centri autorizzati Team Securemme, Key store. Per la duplicazione esibire la security card e una chiave originale.



5) In caso di furto o smarrimento di una o più chiavi o della Security card Securemme suggerisce di sostituire immediatamente il cilindro per mantenere inalterato il livello di sicurezza.

6) Inserire il cilindro ruotando la camma in posizione verticale affinchè rientri all'interno dell'ingombro del corpo cilindro, utilizzando la chiave o il pomolo.

7) Il cilindro non deve sporgere più di 3 mm dal profilo porta per offrire minore presa ad attrezzi di scasso e maggiore resistenza allo "strappo".

8) Lubrificare il cilindro almeno una volta l'anno utilizzando lubrificanti al silicone (tipo WD-40).



9) I cilindri Securemme sono dotati di camma sporgente, per offrire un migliore ancoraggio in caso di sfondamento. È quindi possibile infilare e sfilare il cilindro della serratura senza interventi distruttivi solo disponendo delle chiavi o ruotando il pomolo.

10) Fissare il cilindro alla serratura con attacco Securemme o con l'apposita vite di fissaggio M5X70. Fig. A

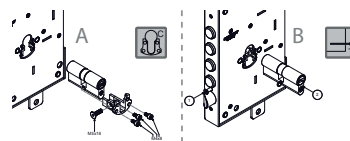

11) Non forzare l'inserimento del cilindro durante il montaggio.

12) Per una maggiore sicurezza si consiglia l'uso in abbinamento di un protector Securemme. Una vera e propria corazza che circonda e protegge il cilindro.



GARANZIA

SECUREMME s.r.l. produce e distribuisce i propri prodotti attenendosi alla disciplina contenuta nella normativa vigente e, in particolare, al disposto di cui al D. Lgs.vo 206/2005 (c.d. "Codice del consumo"). Per quanto riguarda i consumatori, i prodotti SECUREMME s.r.l. sono garantiti da vizi di conformità che si manifestino entro il termine di due anni dalla consegna, come previsto e disciplinato anche dall'art. 132 del D.Lgs.vo 206/2005. I prodotti fabbricati da Securemme Srl sono garantiti per due anni a decorrere dalla data di fatturazione inviata al rivenditore, contro i vizi di progettazione, di materiale o di costruzione riconducibili a Securemme Srl a condizione del normale uso ed installazione. La garanzia è prevista unicamente sul materiale fornito, escludendo qualsiasi riconoscimento per oneri di manodopera o quant'altro necessario allo smontaggio e rimontaggio del prodotto ritenuto difettoso. La garanzia decade qualora il prodotto risulti essere stato soggetto a modifiche, riparazioni da parte di persone non autorizzate. In nessun caso Securemme Srl può essere ritenuta responsabile per qualsiasi danno conseguente alla non idoneità del prodotto in relazione al tipo di impiego a cui viene destinato.



UNI EN 1303:2015



I cilindri EvoK22 sono testati dall'istituto Giordano secondo il rapporto di prova n. 340688, in base alla norma UNI EN 1303/2015, ottenendo nelle varie prove i massimi

The EvoK22 cylinders are tested by the Institute Giordano test report no. 340688 according to the UNI EN 1303/2015 obtaining maximum results in the various tests.



1	2	3	4	5	6	7	8
1	6	0	0	0	C	6	D

2 - DURABILITY: 6 (max = 6 = > 100.000 cycles) 7 - KEY RELATED SECURITY: 6 (max = 6 = > 100.000 combinations) 8 - ATTACK RESISTANCE: D (max = D = 5-10 min)



ANTI-BUMP
ANTI-BUMP



ANTI-TRAPANO
ANTI-DRILL



ANTI-SPEZZAMENTO
ANTI-SNAP



ANTI-PICK
ANTI-PICK

Securemme thanks you for your confidence in choosing this product and recommend you to take a look at the following instructions:

1) HOW TO CHOSE AND MEASURE A CYLINDER

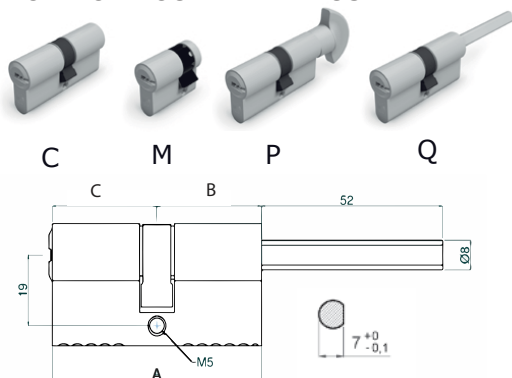

2) SUPPLY

1 site key, 3/5 nickel brass keys, security card in sealed bag. Fixing screw. Ergonomic shape of the key with customizable insert. Patented design and system.

3) SITE KEY SYSTEM

Allows the use of the first key (site key C) during workings. Then when workings are over, you will hand to the final owner the keys in sealed bag: at first use of the sealed keys, the codification is modified thus deactivating the first key



4) SECURITY CARD

The security card protects you against illegal duplications as the keys can be duplicated ONLY at one of the authorized Securemme Teams. The exhibition of the security card and one original key is compulsory before the duplication of it.



5) In case of theft or loss of one or more keys or Security card, Securemme suggests to immediately replace the cylinder to maintain the level of security.

6) Insert the cylinder by rotating the cam in a vertical position so that it is within the overall dimensions of the cylinder body, by using the key or the knob.

7) The cylinder must not protrude more than 3 mm from door to offer less grip to burglary tools and greater resistance to "tear".

8) Lubricate the cylinder at least once a year using silicone lubricant (such as WD-40).



9) Securemme cylinders are equipped with projecting cam lever to offer a better hold in the event of breakage. It is possible to insert and remove the cylinder from the lock without destructive operations, only having available the keys or by turning the knob.

10) Fix the cylinder to the lock with Securemme fixing device or by the proper fixing screw M5x70.

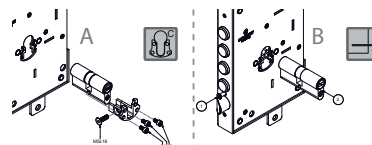

11) Do not force the cylinder during assembly.

12) For an higher security the installation of a Securemme protector is suggested. A real armor that surrounds and protects the cylinder.

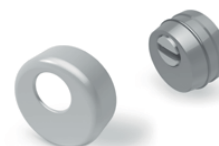

GUARANTEE

SECUREMME LTD manufactures and distributes its products in accordance with the provisions contained in the current legislation and, in particular, with the provisions referred to te D.Lgs.vo 206/2005 (SO-CALLED "Consumer Code"). With regard to consumers, the products SECUREMME s.r.l. are guaranteed by compliance defects occurring within the period of two years from delivery, as provided for and regulated by the art. 132 D.Lgs.vo 206/2005.

With express reference to all the rights and remedies provided in favor of the consumer and governed by the same D.Lgs.vo 206/2005.

Products manufactured by Securemme Srl are guaranteed for two years from invoice date against design, material or manufacture defects, which can be reported to Securemme Srl and under the condition of their normal use and installation. The guarantee is valid only for material which has been supplied, excluding any recognition of charges for labour or anything else necessary for disassembly and re-assembly of a product held to be defective.

The guarantee decays in case the product results modified or repaired by unauthorised people Securemme Srl will not be subject to any responsibility for any damage resulting from the no conformity of the product and relating to its use.